

DOI: <http://doi.org/10.32792/utq.jceps.10.01.015>

Liver Diseases Diagnosis Using Fuzzy Logic

Etab M. Attia¹, Shaker K. Ali²

¹Computer Department, College of Education for Pure Science, University of Thi-Qar, Thi-Qar, Iraq

²Computer Department, Computer Sciences and Mathematics College, University of Thi-Qar, Thi-Qar, Iraq.

Received 29/7/2019

Accepted 17/9/2019

Published 20/1/2020



This work is licensed under a [Creative Commons Attribution 4.0 International License](https://creativecommons.org/licenses/by/4.0/).

Abstract:

In this paper, a new system for liver diseases diagnosis has suggested based on using fuzzy logic by analyzing histological liver images. The suggested system has performed in four steps: the first step is a pre-processing step where the image has enhanced to improve its quality; the goal of image improving is to obtain an image with a high contrast and visual details. The second step is for image analysis by using wavelet transform to decompose and analysis the images into sub-bands. The third step is to extract best features, which will be use the results from the wavelet transform to obtain most important features. The fourth stage is by using the fuzzy logic system to diagnose the livers diseases types (Auto immune, Non-autoimmune, Alcoholic and Hepatitis A, B, C, D and E). The performance of the suggested system has tested and evaluated using 86 histological images and the experimental results confirmed that the proposed system gave 98% accuracy.

Keywords: Fuzzy logic, Liver disease, Hepatitis viral, Features extraction.

1. Introduction:

Liver disease (LD) or disorder is a global public health phenomenon that has continued to rising due to cases of excessive consumption of alcohol, inhaling of harmful gases, intake of contaminated food and drugs health new cases every year. Cases of patients with LD contains. The disease results in liver deterioration due to temporary replacement of liver tissues by fibrous scar tissues, causing it to lose its ability to regulate the metabolic activities of the digestive system [1, 2].

The liver is the largest internal organ in the human body, plays a key role in the metabolism of the body, it provides many vital functions that support every other member of the body and is vital to our survival. Diagnosis used in many different disciplines with slightly different applications to apply logic and experience to determine the relationships between cause and effect. present the computer used in the field of medical science such as to diagnose and Treatment of diseases. To diagnose the disease, the mysterious Fuzzy logic used. In such systems designed, when the results had taken their evaluation, the reliability of the mysterious rules-based system, which is design determine the degree of disease. [3].

2. Methodology:

The methods to analyze images that converting Wavelets (WT), GLCM and Color Time (HSV) to find features used as diagnostic key that is used in Fuzzy logic after finding the feature specified using standard deviation (STD) and means to find the of features.

2.1 Wavelet Transform (WT):

A wave is simply can be defined as an oscillating function of time such as sinusoid. It analyses by a different method by using wave analysis to expand functions or signals to be valuable in different approaches like mathematics, sciences and engineering applications [4][5]. A wavelet is basically a small wave, its energy concentrated in time in order to gain the facilities for the analysis of non-stationary, transient, or time-varying phenomena. It has a wave-like oscillation characteristics and it is capable to allow frequency and time analysis simultaneously with a flexible mathematical basis [4]. The Wavelets Transform (WT) is the mathematical functions, which study each component with a resolution matched to its scale after cutting up data into different frequency components [5]. Because of all previously mentioned features, Wavelet uses in different digital data processing fields such as watermarking [6], image processing [7]and compression [8]. as shown in Figure (1).

LL3	HL3	HL2	HL1
LH3	HH3		
LH2		HH2	
LH1			HH1

Figure1: Structure of wavelet decomposition

2.1.1 Haar Wavelet Transform (HWT):

Discrete. Wavelet. Transform (DWT) is an evaluation image technique in frequency domain. This technique has been created as an extremely efficient and versatile way for decomposing alerts into four sub-bands [9]. DWT decomposes image into four parts using two types of filters namely low Pass Filter. and High Pass Filter. Sub-band images are LL, HL, LH, HH. The first Sub-band is LL which represents low-frequency values, the second sub-band is LH presents vertical information and the third sub-band is HL symbolizes horizontal information whereas for diagonal information is displayed by HH [10]. Relating to [11] important worth is the most affordable sub-band (LL). In its development many reports to improve the performance of DWT filtration systems. Haar mother function has trusted filtering methods in wavelet transforms. DWT with Haar filtration system known as Haar Transform (HWT). This filters have advantages such as successful memory usage, easy and quick [12]. Here is the decomposition process conducted by Haar filter. as shown in Figure (2).

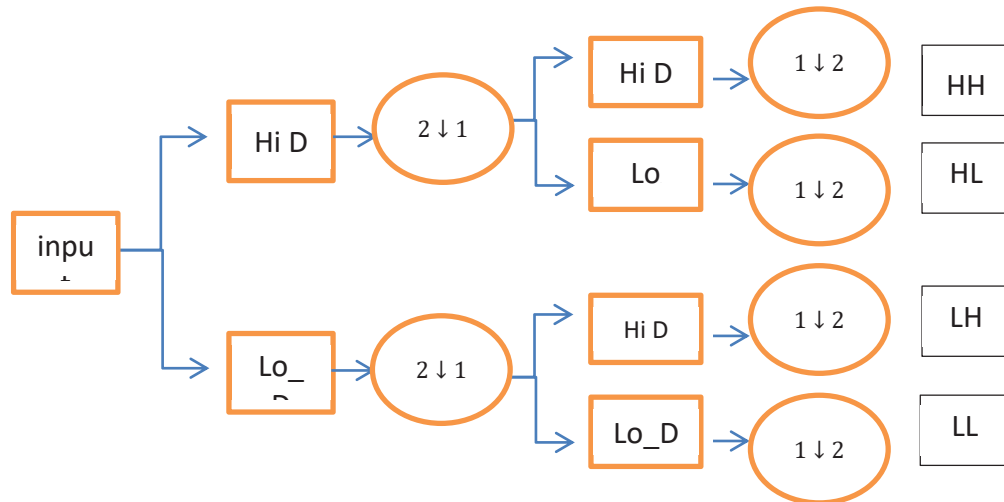

Figure2: Signal Decomposition with Haar filtration systems.

2.2 GreyLevel Co-occurrence Matrix (GLCM):

The texture features consist of contrast, correlation, energy, and homogeneity. All are computed from GLCM

proposed in [13,14] for the four directions (0, 45, 90, and 135) to gray level image of malignant melanoma.

These features are described as below: Contrast measures the amount of local variations in an image.

$$f1 = \sum_{n=0}^{N-1} n^2 \{ \sum_{i=0}^{N-1} \sum_{j=0}^{N-1} p_{d,\theta}(i,j)^2 \} \quad \dots(1)$$

Correlation: is a measurement of gray tone linear dependencies in the image.

$$f2 = \sum_{n=0}^{N-1} \sum_{i=0}^{N-1} \sum_{j=0}^{N-1} p_{d,\theta}(i,j) \frac{(i-\mu_x)(j-\mu_y)}{\sigma_x \sigma_y} \quad \dots(2)$$

Energy: Energy is a measurement of texture uniformity of an image, the more homogeneous the image, the larger the value.

$$f3 = \sum_{i=0}^{N-1} \sum_{j=0}^{N-1} \sum_{j=0}^{N-1} p_{d,\theta}(i,j)^2 \quad \dots(3)$$

Homogeneity: is a measurement of the amount of local uniformity present in the image.

$$f4 = \sum_{i=0}^{N-1} \sum_{j=0}^{N-1} \frac{1}{1+(i+j)^2} p_{d,\theta}(i,j) \quad \dots(4)$$

In this step the images will analysis by using GLCM to extract features where there are 16 features (4 - Correlation, 4- Energy, 4- Homogeneity and 4- Contrast). Each pixel has 8 adjacent pixels allowing 8 choices in four degrees; 0 degrees, 45 degrees, 90 degrees and 135 degrees. However, taking into account the GLCM definition, the common pairs obtained by choosing equal to 0 ° would be similar to those obtained by choosing equal to 180 °. The concept extends to 45° would be similar to those obtained by choosing equal to 225 °, 90° would be similar to those obtained by choosing equal to 270 ° and 135° would be similar to those obtained by choosing equal to 315 °. Sometimes, when the image is mutually

relativistic, or the directional information is not required, one can obtain the properties of the relativistic properties through integration at all angles. [15]

Figure (3.a), shows four gray levels of 4x4 image which extended from 0 to 3. Figure. (3. b) indicates the generic form. of any. GLCM where # denotes the number of elements. Figure (3. c) shows the GLCM calculation for the four directions.

2	2	2	1	(0,0)	#(0,1)	#(0,2)	#(0,3) #
2	2	1	1	(1,0)	#(1,1)	#(1,2)	#(1,3) #
0	1	1	1	(2,0)	#(2,1)	#(2,2)	#(2,3) #
0	0	3	3	(3,0)	#(3,1)	#(3,2)	#(3,3) #

$$P(0^\circ) = \begin{bmatrix} 2 & 1 & 0 & 1 \\ 1 & 6 & 2 & 0 \\ 0 & 2 & 6 & 0 \\ 1 & 0 & 0 & 2 \end{bmatrix} \qquad P(45^\circ) = \begin{bmatrix} 0 & 2 & 1 & 0 \\ 2 & 6 & 0 & 1 \\ 1 & 0 & 4 & 0 \\ 0 & 1 & 0 & 0 \end{bmatrix}$$

$$P(90^\circ) = \begin{bmatrix} 2 & 1 & 1 & 0 \\ 1 & 6 & 2 & 2 \\ 1 & 2 & 4 & 0 \\ 0 & 2 & 0 & 0 \end{bmatrix} \qquad P(135^\circ) = \begin{bmatrix} 2 & 0 & 0 & 0 \\ 0 & 2 & 4 & 2 \\ 0 & 4 & 2 & 0 \\ 0 & 2 & 0 & 0 \end{bmatrix}$$

Figure3: A 4×4 image with its GLCMs for 0°, 45°, 90° and 135°.

2.3 HSV Color Space:

The HSV color space represents colors in terms of Hue (or color depth), saturation (or color purity) and intensity (or color brightness). Color indicates a color type, such as red, blue, or yellow, that takes values from 0 to 360 (but is normalized to 0-100% in some applications). Saturation indicates vitality or color purity. It takes values from 0 to 100%. The lower the color saturation, the more color is mixed in color and the more faded the color.

2.4 Features Extraction:

There are 16 feature which extracted from GLCM as mentioned in GLCM section and also we used two types of features in this suggested system; Standard Deviation (STD) and Mean.

2.4.1 Standard Deviation (STD):

Standard deviation (STD): The standard deviation of the image is calculated as follows: -

$$\text{STD} = \sqrt{\frac{1}{MN} + \sum_{x=0}^{M-1} n^2 \sum_{y=0}^{N-1} (a[x,y] - g)^2 \dots \dots (5)}$$

M = height of the image

N = view image

a [x, y] = Image intensity in coordinates [x, y]

Mean = average image

2.4.2. Mean:

The mean is implement as following [16].

$$mean = \frac{1}{RS} \sum_{r=0}^{R-1} \sum_{s=0}^{S-1} f(r, s) \dots\dots(6)$$

3. The Suggested System:

The proposed System consists of three phases as shown in Figure (4). The first phase is for separate whether the liver diseases is autoimmune or Non-autoimmune, this phase consist from four steps: image acquisition, pre-processing, extraction features and diagnosis. In the second phase identification of autoimmune types (viral hepatitis and alcohol) this phase consists of three steps: separation of types of hepatitis and viral hepatitis through pre-treatment, extraction of features and diagnosis. The third phases are to diagnosis the types of viral hepatitis (A, B, C, D, E) this phase consists of three steps: separation of types of viral hepatitis pre-processing, extraction of features and diagnosis.

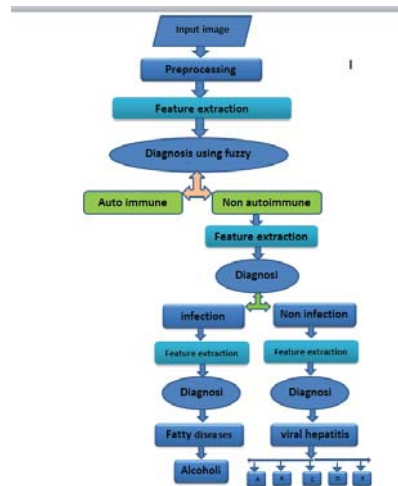

Figure4: The System flow char

3.1 The first phase:

The first phase of the system is to separates the autoimmune or Non-autoimmune that consist from the following steps.

3.1.1 Image acquisitions.

Collecting 86 images as used database images and divided into two groups of images; 64 images for training that divided into 21 images as Auto immune and 43 non autoimmune images, and 22 images for testing group .as shown in Figure. (5).

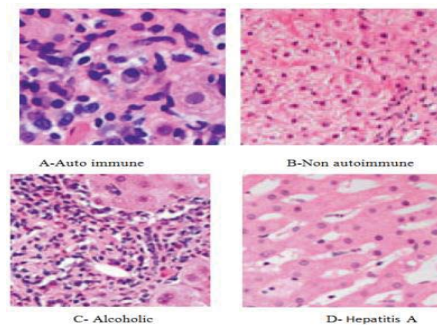

Figure 5: (A and B) Auto immune images, (C and D) non immune.

3. 1.2 Pre-processing:

In this step the images will convert into gray scale and the contrast will increase to make sure that all images to her the same enhancement, as shown in Figure (6).

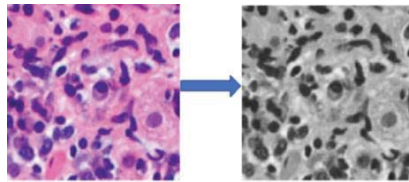

Figure 6: transform a histology image to grey scale image

3.1.3 Feature Extraction:

In this step, the feature that may separate the autoimmune and Non-autoimmune types will extract as described in algorithm 1 and Figure (7).

Algorithm 1: Detecting Liver disease (autoimmune or Non autoimmune)	
Input:	Color images for Liver disease
Output:	one types of Liver disease (autoimmune or Non autoimmune)
Step1:	Re-read the original image (which is diagnosed the image) by convert a histology coloured image into colour moment (HSV) as shown in Figure 7
Step2:	Calculate the mean for H, S and V of HSV image. Where the results show that only three features mean of (H), (S)and (V) gives best results from others which will be inputs into the fuzzy logic.
Step3:	The two inputs are mean of (H), (S), (V)from (step 2) will build THREE rules of fuzzy logic for diagnosis and one output (autoimmune or Non autoimmune). as shown in Figure 9 and Table 1.

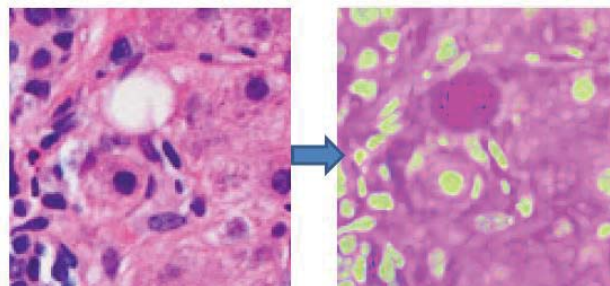

Figure 7: transform a histology image to color moment (HSV) image

3.1.4 Diagnosis:

The objective of the diagnostic step is the diagnosis between autoimmune and Non-autoimmune by using features vector obtained from step 3. Algorithm (2) describes the steps diagnosis as shown in Figure. (10).

Algorithm 2 : Diagnosis	
Input:	Features vector
Output:	type of liver diseases (Auto immune or Non autoimmune)
Step1:	three input fuzzy logic will be the features vector (mean3).
Step 2:	build fuzzy logic (two rules).
Step3:	one output form fuzzy logic (Auto immune or Non autoimmune)

3.2 The second phase:

In this phase, the system will separate the viral hepatitis types and Alcoholic that consist from the following steps:

3.2.1 Pre-processing.

In this step, the color image will convert into a gray scale image, as shown in Figure (6).

3.2.2 Feature Extraction.

Extract features by using GLCM where there are 16 features (four features Correlation (in 0 degree and 45 degree, 90 degree and 135 degree) , 4 features from Energy, 4 features from Homogeneity and 4 features from Contrast).

3.2.3 Diagnosis.

This step used to diagnosis between viral hepatitis types and Alcoholic by using fuzzy logic as shown in Algorithm (3)

Algorithm 3: Detecting liver diseases (viral hepatitis types and Alcoholic)	
Input:	non-autoimmune images.
Output:	one types of Non autoimmune (ductal_alcoholic or viral hepatitis)
Step1:	Re-read the original image (which is diagnosed as alcoholic) by used
Step2:	four input fuzzy logic will be the features vector.
Step 3:	will build two rules of fuzzy logic for diagnosis and one output (alcoholic or viral hepatitis)

3.3 The third phase:

In this phase the system will separates the viral hepatitis types (A, B, C, D and E) in the following steps:

3.3.1 Image analysis.

By using Wavelet Transform into three levels as shown in Figure (8)

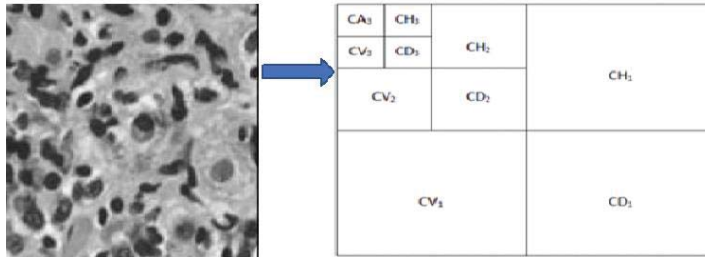

Figure 8: HWT for three levels

3.3.2 Features Extraction.

- a. Calculate CH3, CV3, CD2 and CD3 (the approximately parts of HWT for three levels respectively);
- b. Calculate Standard Division (STD) for CH3, CV3, CD2 and CD3 respectively. There are four features will have obtained (std8, std12, std15, and std16) which be the inputs for the fuzzy logic, as shown in algorithm 4.

Algorithm 4: Image Analysis	
Input:	gray image
Output:	features extraction
Step1:	Finding Haar wavelet to three level. (HWT)
Step2:	Calculate CA1, CA2, CD2 and CA3 for three levels. as shown in Figure 11
Step3:	Calculate STD8, STD12, STD15 and STD16 for step2 respectively. as shown in Figure 12 and Table 4. End

3.3.3 Diagnosis:

Diagnosis the viral hepatitis types (A, B, C, D, and E) as shown Algorithm (5).

Algorithm 5: Diagnosis	
Input:	Features vector
Output:	type of hepatitis viral (A, B, C, D, E)
Step1:	five input fuzzy logic will be the features vector (STD8, STD12, STD15, and STD16)
Step 2:	build fuzzy logic (five rules), as shown in Figure 13 and Table 5.
Step3:	one output form fuzzy logic (A, B, C, D, E) as shown in Figure 14

4. Results

The Many experiments are performed to explore the possibility of selecting the best parameters for a mysterious logic workbook. Table (1), Table (2) , Table (3) and Table (4) show different experimental results for the foggy logic that has been trained for. The success of our proposed system in identifying the type of disease where we get the recognition rate is 100% in the training phase and 98% in the testing phase.

Table 1: (mean1, mean2, mean3) For (Autoimmune)

Image no	mean1	mean2	mean3
Image 1	0.841527	0.474747	0.871979
Image 2	0.829118	0.490163	0.846088
Image 3	0.845954	0.471351	0.868722
Image 4	0.817513	0.495968	0.828819
Image 5	0.871923	0.400161	0.810568
Image 6	0.833431	0.490426	0.836316
Image 7	0.823111	0.499844	0.845617
Image 8	0.857626	0.426315	0.845549
Image 9	0.87389	0.431435	0.907715
Image 10	0.888611	0.342423	0.900582
Image 11	0.88576	0.391738	0.90614
Image 12	0.883217	0.380017	0.902993
Image 13	0.88962	0.357265	0.902058
Image 14	0.876614	0.411292	0.906009
Image 15	0.853091	0.393177	0.883274
Image 16	0.853513	0.315373	0.807232
Image 17	0.806281	0.408532	0.85692
Image 18	0.822667	0.499419	0.844935
Image 19	0.858002	0.408605	0.797321
Image 20	0.858577	0.374942	0.861618
Image 21	0.870232	0.335997	0.844231

Table 2: (mean1, mean2, mean3) For (non autoimmune)

Image no	mean1	mean2	mean3
Image 1	0.913161	0.302406	0.917006
Image 2	0.925398	0.271806	0.913461
Image 3	0.927748	0.26931	0.916214
Image 4	0.917919	0.274642	0.91596
Image 5	0.924686	0.270039	0.908184
Image 6	0.92988	0.199811	0.872194
Image 7	0.923481	0.21157	0.895363
Image 8	0.927478	0.243269	0.906292
Image 9	0.921557	0.278756	0.908327
Image 10	0.937146	0.404293	0.913974
Image 11	0.940828	0.445985	0.915802
Image 12	0.945752	0.266387	0.87258
Image 13	0.953388	0.290168	0.890916
Image 14	0.942113	0.379496	0.910639
Image 15	0.933597	0.320771	0.88641
Image 16	0.946598	0.397797	0.779456
Image 17	0.950732	0.412939	0.78538
Image 18	0.908848	0.421827	0.76924
Image 19	0.951359	0.410804	0.786349
Image 20	0.907926	0.42846	0.780129
Image 21	0.911007	0.425728	0.776598
Image 22	0.936319	0.423774	0.782623
Image 23	0.937069	0.419283	0.779349
Image 24	0.96251	0.300191	0.86466
Image 25	0.956464	0.32645	0.860861
Image 26	0.955512	0.32626	0.858881
Image 27	0.965189	0.294879	0.857922
Image 28	0.957286	0.313958	0.862598
Image 29	0.96075	0.303188	0.863071
Image 30	0.925126	0.245251	0.671337
Image 31	0.912924	0.319136	0.866979
Image 32	0.90092	0.383257	0.885816
Image 33	0.923018	0.297626	0.864241
Image 34	0.908771	0.364434	0.889178
Image 35	0.930885	0.273032	0.872689
Image 36	0.914729	0.351541	0.891121
Image 37	0.92941	0.290808	0.879753

In the table1 and table2 three inputs by calculate (MEAN) for (H)of colour moment (H, S, V) for diagnosis the two Auto immune or Non autoimmune types three features mean of (V), (S)and (V) gives best results from others which will be inputs into the fuzzy logic. As show in Algorithm 1

Table 3: Input Rules

Rule No.	Describe
1	IF (input1 is low) AND (input3 is low) THEN (output is Auto immune)(1)
2	IF (input3 is high) THEN (output is Non autoimmune)(1)

In the table (3): will build THREE rules of fuzzy logic for diagnosis and one output (autoimmune or Non autoimmune). as shown in the steps Algorithm 1

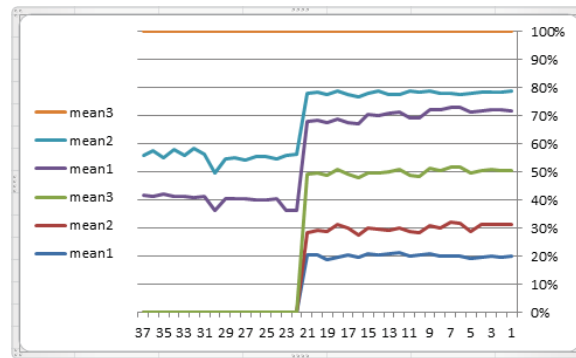

Figure 9: mean for Auto immune and Non autoimmune

As shown in Figure 9, use the min values and the max values for mean to extract the features that give the final results (autoimmune or autoimmune)

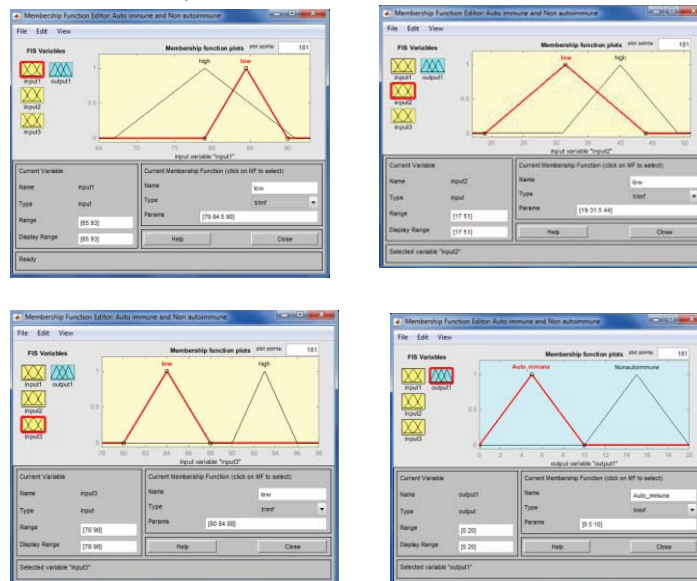

Figure 10: Inputs and Outputs Types Auto immune or Non autoimmune model Mamdani

As show in Figure (10) four features used as four inputs of fuzzy logic which give the final results (Auto immune or Non autoimmune)

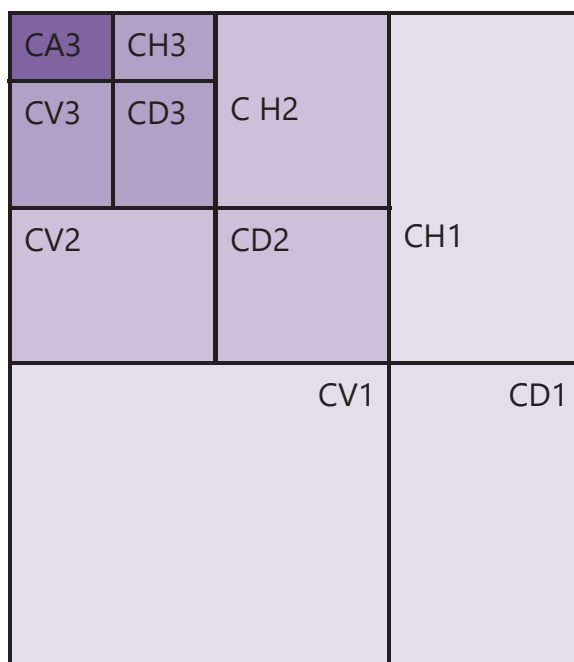

Figure 11: DWT for three levels

experiments have shown that CA1, CA2, CD2 and CA3 are the best parts to provide the best diagnostic feature, whether alcoholic or viral hepatitis. as shown in steps Algorithm 3.

Table 4: STD for viral hepatitis

	St12 E	St8 E	St15 D	St16 C	St12 C	St15 B	St16 A	St12 A
	258.5	188.4	55.2	49.31	52.07	67.54	75.32	107.2
	240.6	198.6	62.68	54.76	55.17	64.03	65.54	98.93
	226.6	152.2	60.24	52.15	58.08	72.54	63.09	75.2
	232.1	190.7	52.62	50.19	54.81	66.52	74.67	108.8
	190.6	209.9	60.29	44.01	49.29	66.53	71.63	105.9
	210.7	191	52.32	46.2	49.47	68.29	90.99	102.8
	191.4	161.6		46.25	48.8		72.55	88.28
	161.2	166.4		51.54	51.88		75.68	108.3
							72.18	93.97
min	161.2	152.2	52.32	44.01	48.8	64.03	63.09	75.2
max	258.5	209.9	60.29	54.76	58.08	72.54	90.99	108.8

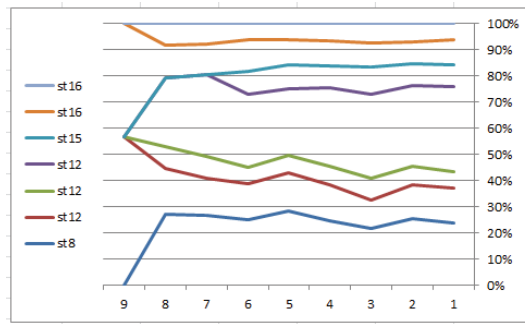

Figure (12): ST for STD for viral hepatitis

After analysis the image by using DWT, we can extract the features for three levels and minimize the large features by using Standard Division (STD), as shown in Table (2) and Figure (11).

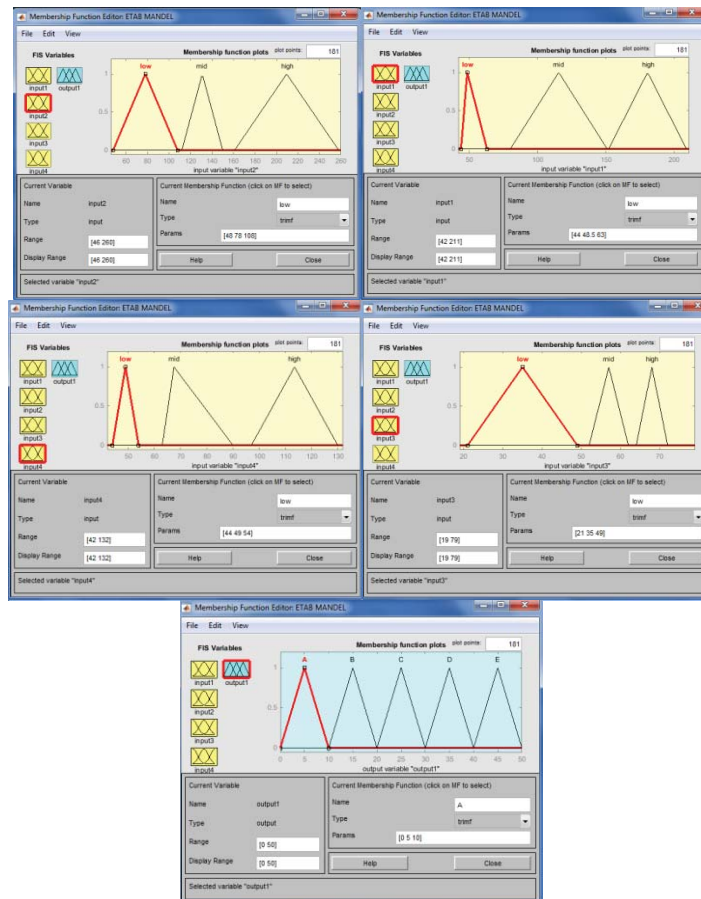

Figure (13): Inputs and Outputs types hepatitis viral model Mamdani model

Table 5: Fuzzy Rules

No	Rule
1	IF (input st8 is low) AND (input st16 is mid) THEN (output1 is A)(1)
2	IF (input st15 is high) THEN (output1 is B)(1)
3	IF (inputst8 is low) AND (inputst12 is low) AND (inputst16 is low) THEN (output1 is C)(1)
4	IF (inputst15is mid) THEN (output1 is D)(1)
5	IF (inputst8 is high) AND (inputst12 is high) THEN (output1 is E)(1)

In the Table (5): will build five rules of fuzzy logic for diagnosis and one output (viral hepatitis types (A, B, C, D, and E)). as shown in steps Algorithm 4.

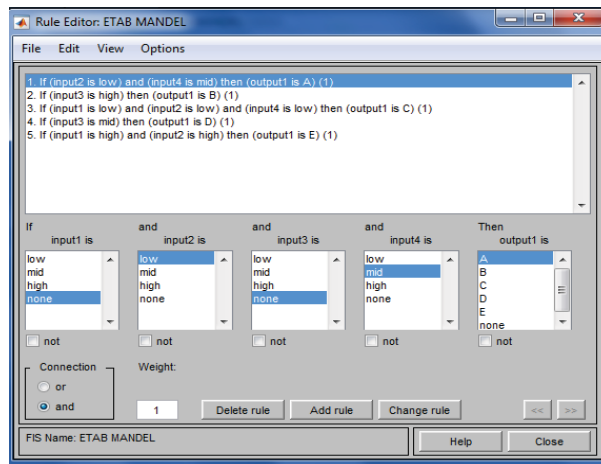

Figure 14: Input Rules

after Many experiments are performed the fuzzy logic gives best results from others which for achieve a high classification rate for diagnosis between viral hepatitis types (A, B, C, D, E)

5.COMPRESSION OUR ALGORITHM WITH OTHERS:

There are many researches in diagnosis Liver diseases or detection, so that there are difference result and difference accuracy of researches. Table.6 shows our proposed system accuracy and Table.7 shows the difference between our proposed system with other researches algorithms.

Table.6 shows our proposed system accuracy

Stages	No. of images	Accuracy
Training	86	100%
Testing	38	98%

Table.7 shows the difference between proposed system with others

Researcher	The algorithm used	Accuracy
Vibhakar Shrimali. 2010	Comparing the Performance of Ultrasonic Liver Image Enhancement Techniques: A Preference Study	76%
Dr. M. S. Ali. 2013	A Fuzzy Expert System for Pathological Investigation and Diagnosis of Jaundice	90%
Nitin Sahai. 2014	Diagnosis of the jaundice using fuzzy expert system	92%
Asma Hashmia. 2015	fuzzy inference is used to formulate mapping of given input to output.	86%
MarwaI .M. Obayya.2016	adaptive neuro-fuzzy inference system (ANFIS) model	95%
Rahmon Ibrahim. 2018	Diagnosis of Hepatitis using Adaptive Neuro-Fuzzy Inference System (ANFIS)	90.20%
Gulzar Ahmad.2019	fuzzy inference system	92.2%
Our algortihm proposed	liver diseases diagnosis by using fuzzy logic	98%

6. Conclusion:

In this paper, we will help the doctor to diagnose diseases and away from ambiguity in the doctor's thinking process and accuracy of classification obtained, and this will help to give a realistic solution to the problem. It is important to work in the field of early detection of Liver diseases by using histological images because of the multiplicity of devices used in obtaining histological images and their accuracy, in addition to the distortions that occur during the conservation and storage phase of microscopic microscopy. Through the proposed algorithm and the conclusions reached, we recall the following conclusions for recognition and diagnosis the two types of Liver diseases based on color features in general, the color model (HSV) that led to higher recognition results in color images. through used colour moment for each part of HSV (H, S, V respectively), and calculate (Mean) .In our algorithm we used mean, the best feature for diagnosis whither the Liver diseases is auto immune or Non autoimmune, As well that offer the best features to diagnose the types of alcoholic or viral hepatitis -GLCM-dependent with 16 distributed features using (contrast, energy, correlation, homogeneity at 0 °, 45 °, 90 °, 135) ,As well In our algorithm we used separate waveform conversion with three levels for each four-part level; the total number of parts is 12 separate parts; CA1, CH1, CV1, CD1, CA2, CH2, CV2, CD2, CA3, CH3, CV3, CD3) But the trials show that CA1, CA2, CD2 and CA3 are the best parts that will provide the best diagnostic feature where liver diseases are: types of viral hepatitis. We hope that the work will lead to more specialized medical decision to help patients detect autoimmunity and others.

6. REFERENCES:

- [1] . Bendi, V.R, Surendra, M. P., Venkateswarlu, N. B, “A Critical Study of Selected Classification Algorithms for Liver Disease Diagnosis”, International Journal of Database Management Systems (IJDMs), Vol.3, No.2, 2011, pp 102-104.

- [2] . Karthik, S., A. Priyadarishini, J. Anuradha, B. K. Tripathy, “Classification and Rule Extraction using Rough Set for Diagnosis of Liver Disease and its Types”, *Journal of Advances in Applied Science Research*, Vol. 2 No. 3, 2011.
- [3] . Ekong, V.E., 2 Onibere, E.A., 3 Imianvan, A.A "Fuzzy Cluster Means System for the Diagnosis of Liver Diseases" *IJCST Vol. 2, Issue 3, September 2011*.
- [4] C. Sidney Burrus, Ramesh A. Gopinath, and Haitao Gue. “Introduction to Wavelets and Wavelet Transforms: A primer”. Prentice Hall Inc. Upper Saddle River, New Jersey. USA. 1998.
- [5] Graps, Amara. "An introduction to wavelets." *IEEE computational science and engineering* 2, no. 2 (1995): pp 50-61.
- [6] Ganic, E and Eskiciogulu, AM and others. “Robust embedding of Visual Watermarks using DWTSVD *Journal of Electronic Imaging*”, 2005.
- [7] Polikar R, Keinert F, Greer M.H. (2001). Wavelet analysis of event related potentials for early diagnosis of Alzheimer’s disease. In: A. Wavelets in Signal and Image Analysis, From Theory to Practice, Kluwer Academic Publishers, Boston, 2001.
- [8] AlMuhit A, Islam S. and Othman M. (2004). VLSI Implementation of Discrete Wavelet Transform (DWT) for Image Compression. 2nd International Conference on Autonomous Robots and Agents December 13-15, 2004 Palmerston North, New Zealand
- [9] . D. Gupta and S. Choubey, “Discrete Wavelet Transform for Image Processing,” *International Journal of Emerging Technology and Advanced Engineering*, vol. 4, no. 3, pp. 598-602, 2015.
- [10] . A. Susanto, D. R. I. M. Setiadi, C. A. Sari, and E. H. Rachmawanto, “Hybrid Method using HWT-DCT for Image Watermarking,” *International Conference on Information Technology for Cyber and IT Service Management (CITSM)*, Denpasar, 2017.
- [11] . M. M. Sathik and S.S. Sujatha, “A Novel DWT Based Invisible Watermarking Technique for Digital Images,” *International Arab Journal of e-Technology*, vol. 2, no. 3, pp. 167-173, 2012.
- [12] . P. W. Adi, F. Z. Rahmanti and N. A. Abu, “High Quality Image Steganography on Integer Haar Wavelet Transform using Modulus Function,” in *International Conference on Science in Information Technology (ICSITech)*, Yogyakarta, 2015.
- [13] . Sunita P. Aware “Image Retrieval Using Co-Occurrence Matrix & Texton Co-Occurrence Matrix for High Performance” *International Journal of Advances in Engineering & Technology*, Vol. 5, Issue 2, pp. 280-291. 2013.
- [14] Fritz Albregtsen, “Statistical Texture Measures Computed from Gray Level Co-occurrence Matrices”, *Image Processing Laboratory Department of Informatics University of Oslo* November 5, 2008.
- [15] R. K. Thakur and C. Saravanan, "Classification of color hazy images," in *Electrical, Electronics, and Optimization Techniques (ICEEOT)*, International Conference on, 2016, pp. 2159-2163.
- [16] M. M. Sathik and S.S. Sujatha, “A Novel DWT Based Invisible Watermarking Technique for Digital Images,” *International Arab Journal of e-Technology*, vol. 2, no. 3, pp. 167-173, 2012